

SENTINEL®

Vortex200

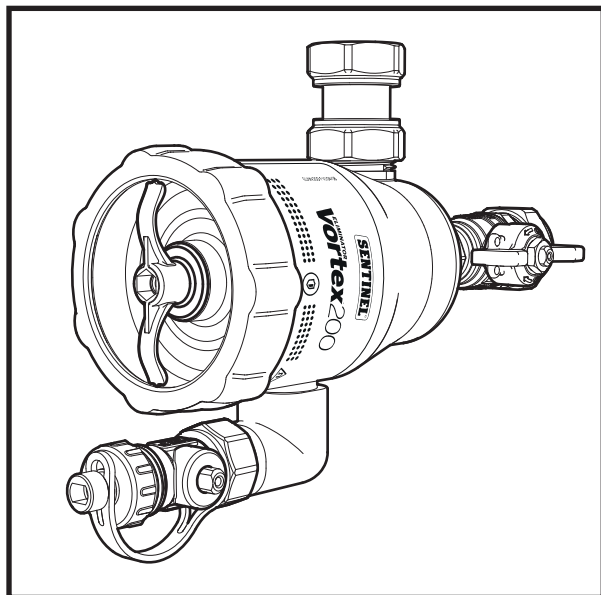

07/2018

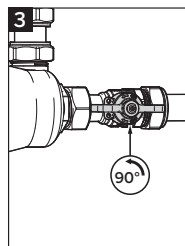
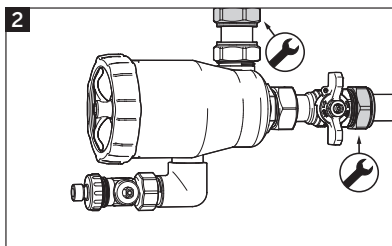
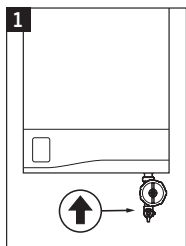
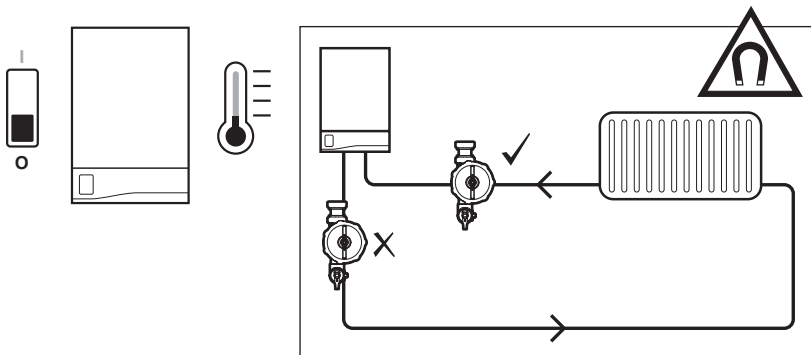
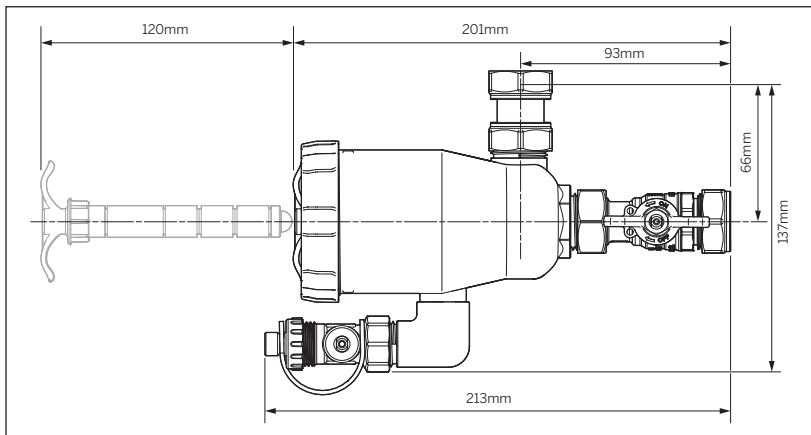

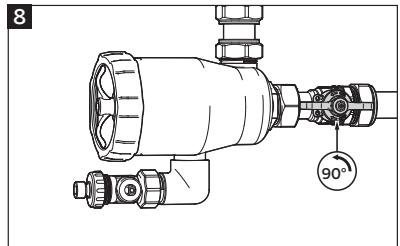
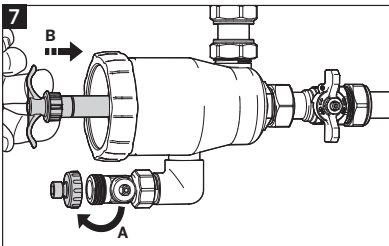
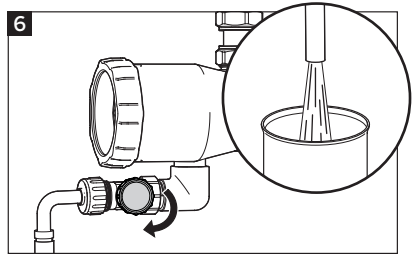
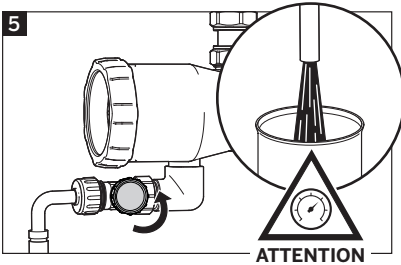
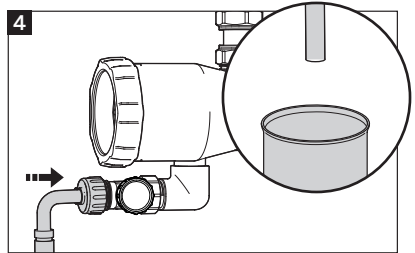
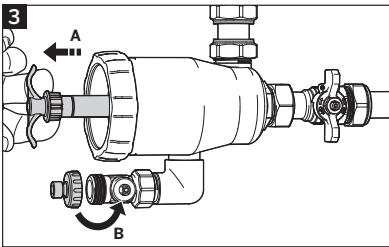
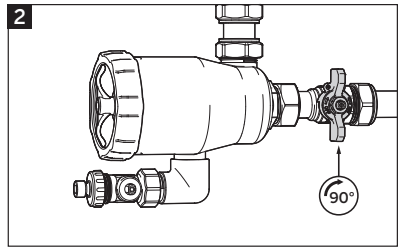
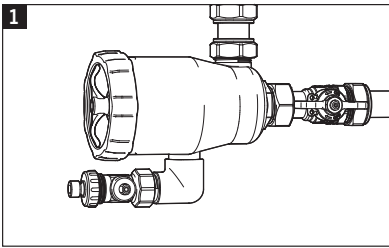



10 anni di garanzia

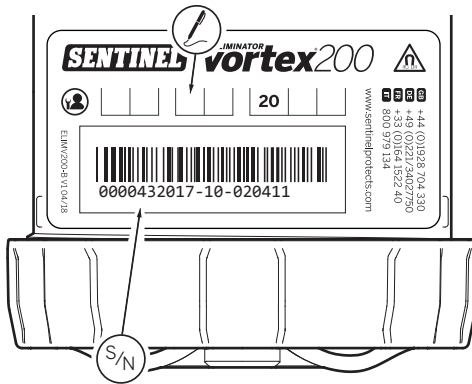

www.sentinelprotects.com/it/registrazione-garanzia



				20	
--	--	--	--	----	--

S/N

											-			-						
--	--	--	--	--	--	--	--	--	--	--	---	--	--	---	--	--	--	--	--	--